

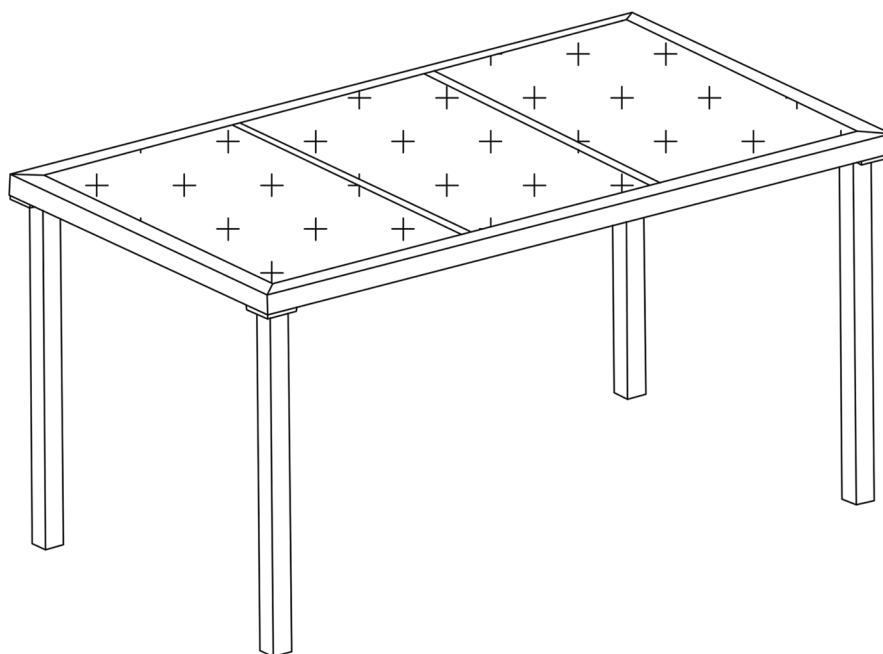

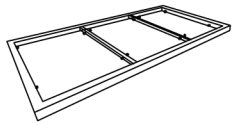

# Saint Tropez 6

1165\_86755/1165\_86757/1165\_86759

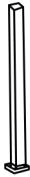
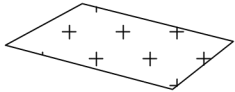

1165\_86755/86757/86759

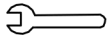
A1		1500x900x740mm	X1	1/1
B		680x50x50mm	X4	1/1
C		785x542x50mm	X3	1/1
D		M6x25mm	X12	1/1
E		∅6x1mm	X12	1/1
F		M6	X8	1/1
G		M6	X1	1/1
H		M6	X1	1/1

FR : SAV/INFORMATION /VIDEO/CONTACT

EN: AFTER-SALES SERVICE/INFORMATION/VIDEO/CONTACT

DE : REPARATUR-SERVICE UND ERSATZTEILE //INFORMATIONEN /VIDEO/KONTAKT

ES: SERVICIO POST-VENTA/INFORMACIÓN/VIDEO/CONTACTO

IT: SERVIZIO ASSISTENZA/INFORMAZIONI/VIDEO/CONTATTO

PT: SERVIÇO PÓS-VENDA/INFORMAÇÕES/VIDEO/CONTATO

PL: SERWIS TECHNICZNY//INFORMACJE/WIDEO/KONTAKT

NE: AFTER SALES SERVICE/INFORMATIE/VIDEO/CONTACT

HE: עם לתקשר/הווידיאו/ מידע/ומכירות שירות לאחר

[SAV.HABITATETJARDIN.COM](http://SAV.HABITATETJARDIN.COM)

## FR

- Il est conseillé d'attendre d'avoir monté entièrement votre produit avant de serrer complètement vos vis.
- Evitez d'exposer le plateau de verre directement aux rayons de soleil lors de fortes chaleurs.
- Il est conseillé de protéger vos produits à l'aide d'une housse de protection afin de les préserver des intempéries et de la poussière.
- En hiver, stockez vos produits à l'abri dans un endroit sec.
- Ne jamais utiliser des produits chimiques pour le nettoyage.

## EN

- It is advisable to wait until you have fully assembled your product before tightening your screws completely.
- Avoid exposing the glass tray under sunlight during high heat.
- It is advisable to put your products into cover to protect them from the severe weather and dust.
- In winter, store your products in a dry place.
- Never use chemical products for cleaning.

## DE

- Es ist ratsam, für Ihre vollständig montiert zu warten, bevor vollständig Ihre Schrauben festziehen.
- Vermeiden Sie die Glasschale direkt mit Sonnenlicht während der schweren Hitze auszusetzen.
- Es wird empfohlen, Ihre Produkte mit einer Schutzabdeckung zum Schutz vor Witterung und Staub zu schützen.
- Im Winter, speichern Sie Ihre Waren an einem trockenen Ort.
- Verwenden Sie niemals Chemikalien zur Reinigung.

## ES

- Se aconseja montar totalmente el producto antes de apretar completamente todos los tornillos.
- Se aconseja cubrir los productos con una funda para protegerlos de las intemperies y del polvo.
- Seque inmediatamente su mobiliario para evitar las marcas.
- En invierno, almacene los productos en un lugar seco.
- Nunca utilice productos químicos para la limpieza.

## IT

- È consigliato di aspettare di avere montato interamente il prodotto prima di stringere completamente le viti.
- Evitate di esporre direttamente il vassoio di vetro al sole soprattutto durante i periodi di gran calore.
- È consigliato di proteggere i prodotti con un sacco di protezione per preservarli dal brutto tempo e dalla polvere.
- Durante l'inverno, mettere i prodotti al riparo in un luogo secco.
- Mai usare prodotti chimici per pulire i prodotti.

